

24 VOLT APPLICATIONS

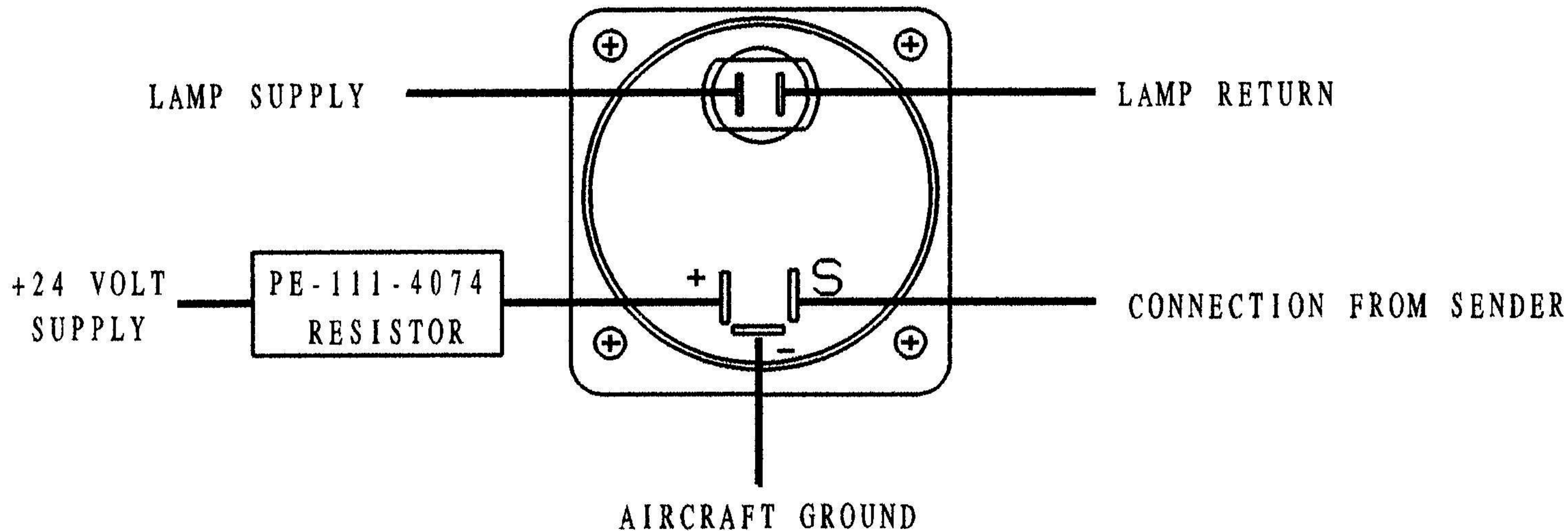

NOTE: SENDING UNIT MUST BE GROUNDED FOR PROPER OPERATION
WIRE ACCORDING TO MARKS ON CONNECTOR, CONNECTOR MAY BE
ROTATED FROM ORIENTATION AS SHOWN.